



OSLO & RIVIERA

Wall Mounted Shelf Unit
Installation Guide

Table of Contents

INSTALLATION VIDEO	3
WHAT'S INCLUDED - BRACKET ORDERS	4
WHAT'S INCLUDED - UNIT ORDERS	5
PLAIN GLASS (NO METAL CASING) INSTALLATION INSTRUCTIONS	6
WOOD UNIT INSTALLATION INSTRUCTIONS	10
GLASS OR METAL UNIT INSTALLATION INSTRUCTIONS	14
3 BRACKET GLASS OR METAL UNIT INSTALLATION INSTRUCTIONS	17
EXCHANGE & RETURN POLICY	19

Installation Video

VIEW OUR INSTALLATION VIDEO FOR MORE HELP.

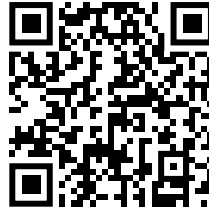

TOOLS YOU WILL NEED:



Drill Bit

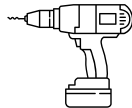

Drill

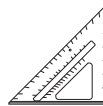

Square (Optional)



Screw Driver



Pencil

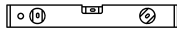

Level

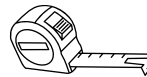

Measuring Tape

















Tape

Due to every home being unique (varying construction materials and methods), IRON ABODE's products must be installed by licenced professionals to ensure their products will work for your specific application. Incorrect installation of our products could result in sagging shelves, damage, injury, or death. IRON ABODE is not liable for the incorrect installation of their products.

What's in the package?

BRACKETS















	 1 SHELF Shelf Length: < 48"	 1 SHELF Shelf Length: 48"	 2 SHELF Shelf length: < 48"	 2 SHELF Shelf length: 48"	 3 SHELF SET Shelf length: 48"	 3 SHELF SET Shelf length: 48"	 4 SHELF SET Shelf length: < 48"	 4 SHELF SET Shelf length: 48"	 5 SHELF SET Shelf length: < 48"	 5 SHELF SET Shelf length: 48"
 BRACKETS (Quantity ordered will be the quantity you receive)	QTY 1=1 2 are required for this shelf length	QTY 1=1 3 are required for this shelf length	QTY 1=1 2 are required for this shelf length	QTY 1=1 3 are required for this shelf length	QTY 1=1 2 are required for this shelf length	QTY 1=1 3 are required for this shelf length	QTY 1=1 2 are required for this shelf length	QTY 1=1 3 are required for this shelf length	QTY 1=1 2 are required for this shelf length	QTY 1=1 3 are required for this shelf length
 LAG SCREWS	4*	6*	4*	6*	4*	6*	4*	6*	4*	6*
 SHELF SCREWS	4*	4*	8*	8*	12*	12*	16*	16*	20*	20*

*Amounts included are based on if you purchase the required amounts above.

The provided hardware is for installing into studs or sturdy blocking. Your licensed professional should take this into account during installation.

What's in the package?

UNITS

	 1 SHELF SET Shelf Length: < 48"	 1 SHELF SET Shelf Length: 48"+	 2 SHELF SET Shelf Length: < 48"	 2 SHELF SET Shelf Length: 48"+	 3 SHELF SET Shelf Length: < 48"	 3 SHELF SET Shelf Length: 48"+	 4 SHELF SET Shelf Length: < 48"	 4 SHELF SET Shelf Length: 48"+	 5 SHELF SET Shelf Length: < 48"	 5 SHELF SET Shelf Length: 48"+
 SHELF SET (Complete Units only)	1	1	2	2	3	3	4	4	5	5
 BRACKETS (Automatically included in Complete Units only)	2	3	2	3	2	3	2	3	2	3
 LAG SCREWS	4	6	4	6	4	6	4	6	4	6
 SHELF SCREWS	4	4	8	8	12	12	16	16	20	20

The provided hardware is for installing into studs or sturdy blocking. Your licensed professional should take this into account during installation.

Oslo & Riviera Plain Glass Units

2+ people needed for installation



STEP 1

Place 1 bracket on ceiling, on a joist or sturdy blocking. Use a level to ensure the bracket is straight. Then use a marker to mark the bracket's mounting holes locations. Use your shelf's length to measure the desired bracket spacing from the marked holes. Mark this length with painters tape. Please note: if you are using glass shelves, you should have a 3" overhang for safety (see step 4 for clarification).

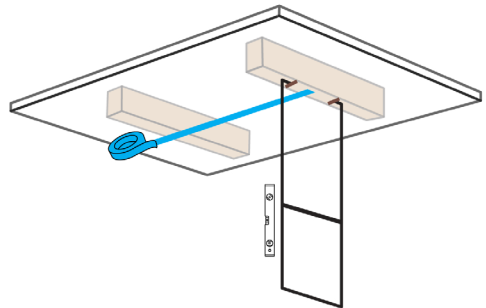

Design: @hayeskerry

Oslo & Riviera Plain Glass (No Metal Casing) Unit

STEP 2

Measure the spacing from the wall to the first bracket's nearest mounting hole. Use this measurement to mark the second bracket's nearest mounting hole. Line up a bracket with this newly marked mounting hole and use a level to ensure it is straight. Mark the other mounting holes for the second bracket.

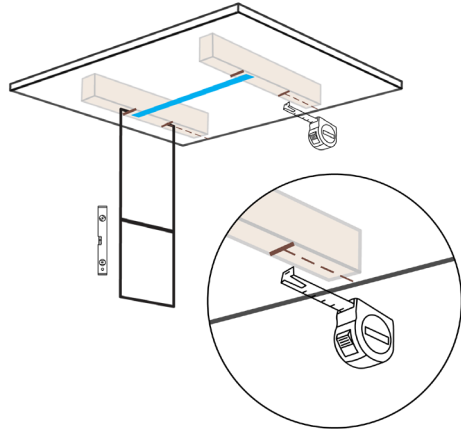



STEP 3

For maximum capacity, we recommend that this unit be installed into joists or sturdy blocking. Using a 1/16" drill bit, drill pilot holes into each marking. **Failure to drill these pilot holes could make the lag screws break during install.**

Use the provided long screws to install the brackets. If one bracket needs to be installed into drywall, use heavy duty drywall anchors.*

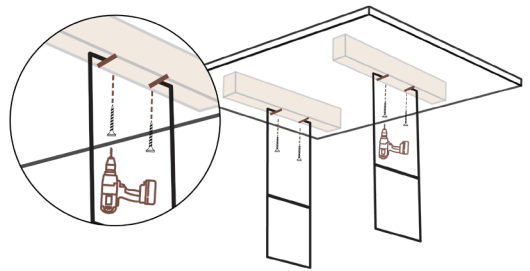

**Please note: If you are using drywall anchors, we suggest using our high capacity drywall anchors. Your specific drywall construction as well as the capacity of your drywall anchors will determine how much your unit will hold. Your licensed professional should take this into account during installation.*

Oslo & Riviera Plain Glass (No Metal Casing) Unit

STEP 4

For glass shelves without metal casings: A minimum 3" overhang (length your shelf extends past your brackets) is required for safety. Place the provided (upon request) clear adhesive strips on the shelf rungs. Then carefully place your glass shelves on your brackets.

Enjoy your new unit!

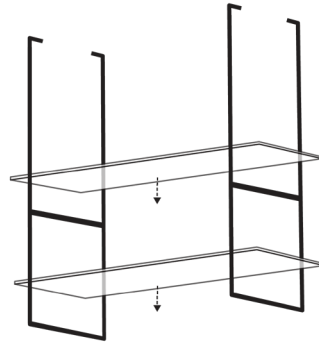

PLAIN GLASS UNIT

**Important: Your brackets may sway a little. This is normal until a load/ shelves are placed/ secured onto the brackets. If you plan on using glass shelves with no casing, you will need to discuss options with your glass shop or contractor and get holes drilled into your glass shelves. For glass shelves, we suggest a minimum of a 3" overhang on each side and can provide adhesive upon request. However, this will not ensure that your brackets will completely stop swaying, especially if bumped into.*

Oslo & Riviera Wood Units

2+ people needed for installation



STEP 1

Lay brackets long ways on the floor. Place 1 shelf on the brackets and mark where the set screws will need to be drilled into the shelves (2 underneath each end of the shelf). Repeat for each side of each additional shelf.

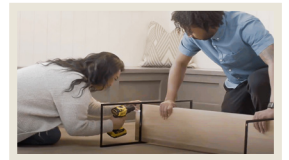
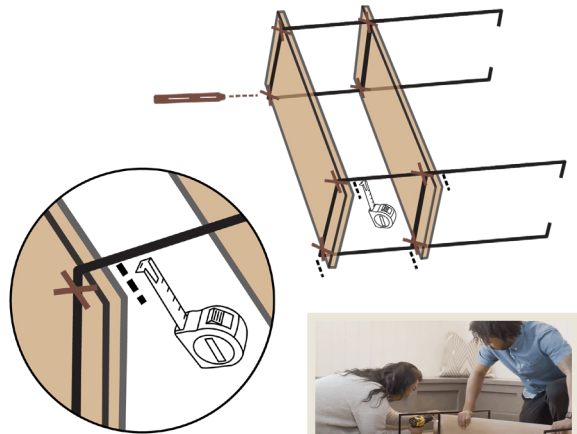

Oslo & Riviera Wood Unit

STEP 2

With a 1/16" drill bit, drill shallow pilot holes into the previously marked location. Repeat on each side of each shelf.

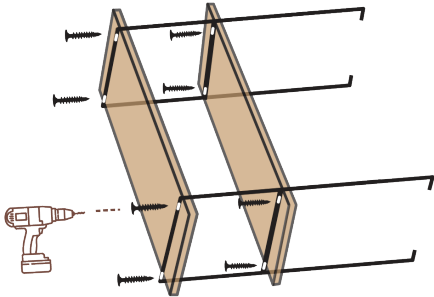
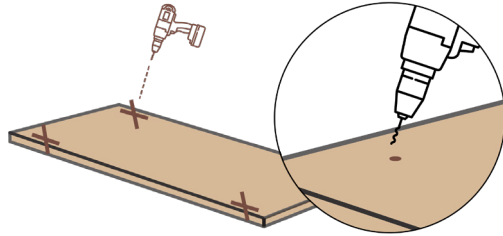

STEP 3

Place the brackets long ways on the floor again. Now place 1 shelf on the brackets and mount each short screw into the pre-drilled holes. Repeat on each end of each additional shelf.



Please note: If you do not pre-drill a hole before drilling the screw in, the shelves may split.



STEP 4

Bring the unit to the ceiling and mark where you will need to install the unit, using a level to ensure your unit is straight.

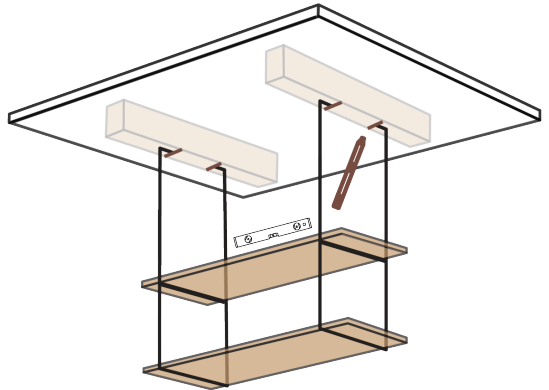

**Important: Your brackets may sway a little. This is normal until a load/ shelves are placed/ secured to the brackets.*

Oslo & Riviera Wood Unit

STEP 5

Take shelves off the brackets. Using a 1/16" drill bit, drill pilot holes into each marking. **Failure to drill these pilot holes could make the lag screws break during install.** Line up your unit with your marked holes and lines, then install the brackets using the lag screws. Once your brackets are secure, install the shelves onto the brackets.

Enjoy your new unit!

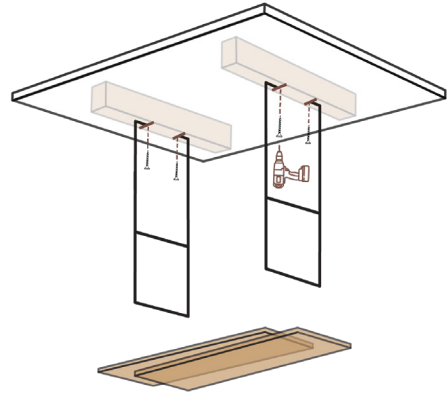

WOOD UNIT

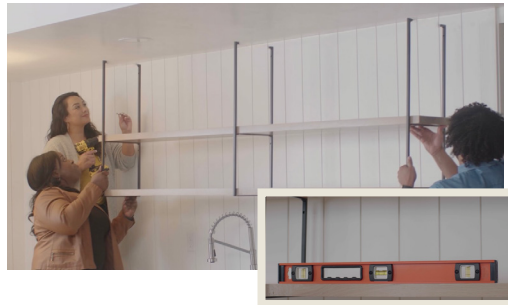
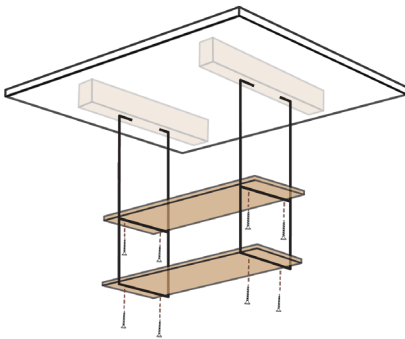

**Please note: If you are using drywall anchors, we suggest using our high capacity drywall anchors. Your specific drywall construction as well as the capacity of your drywall anchors will determine how much your unit will hold. Your licensed professional should take this into account during installation.*

Oslo & Riviera Glass or Metal Units

2+ people needed for installation



STEP 1

Lay brackets long ways on the floor. Place 1 shelf casing (for glass shelves) or metal shelf on the brackets and line up the ends. Push the larger bolt through the bottom of hole, then feed the smaller bolt through the top of the hole- now screw them together. Repeat for each side of each additional shelf.

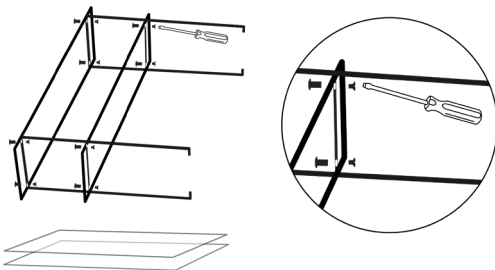

**Important: Your brackets may sway a little. This is normal until a load/ shelves are placed/ secured to the brackets.*

Oslo & Riviera Glass or Metal Unit

STEP 2

For maximum capacity, we recommend that this unit be installed into joists or sturdy blocking. Hold the assembled unit against ceiling or use a measuring tape to mark the mounting hole locations. If one bracket needs to be installed into drywall, use heavy duty drywall anchors.*

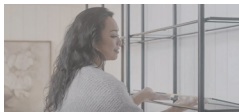
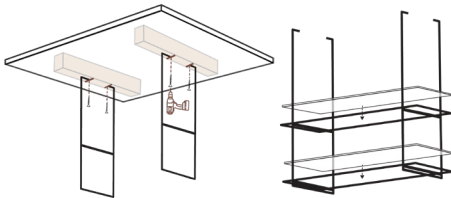

STEP 3

Remove your casings or shelves from the brackets. Using a 1/16" drill bit, drill pilot holes into each marking. **Failure to drill these pilot holes could make the lag screws break during install.** Line up your brackets with your marked holes and lines, then install the brackets using the lag screws. Once your brackets are secure, install your casings/shelves back onto the brackets. Then carefully place glass into casings. Enjoy your unit!

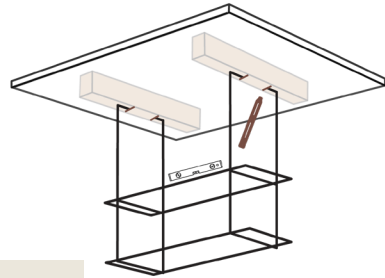

**Please note: If you are using drywall anchors, we suggest using our high capacity drywall anchors. Your specific drywall construction as well as the capacity of your drywall anchors will determine how much your unit will hold. Your licensed professional should take this into account during installation.*

Oslo & Riviera 3 Bracket Units

2+ people needed for installation

STEP 1

Lay brackets long ways on the floor. The 2 brackets with holes will be your end brackets. The bracket without holes will be your middle bracket. Slide your shelf casings together. The casings may need to be tapped together by holding one end steady and tapping the other end. Once the casings are together, move to STEP 2 on the next page.



Casing Assembly



Oslo & Riviera 3 Bracket Glass or Metal Unit

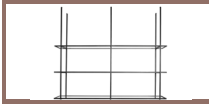

Please note: If you don't use the middle bracket for shelves 48" + long, then your unit will not achieve its given load rating and there's a chance your shelves will sag.

STEP 2

Place a shelf casing (for glass shelves) or metal shelf on the brackets and line up shelf holes (on the ends) with the bracket holes. Push the larger bolt through the bottom of hole, then feed the smaller bolt through the top of the hole- now screw them together by hand. Repeat for each side of each additional shelf.

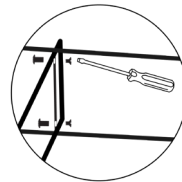

Bolt Assembly



STEP 3

The middle bracket is there to stabilize the unit and prevent sagging. Use the clear adhesive to secure the middle of the shelves to the middle bracket. Go to STEP 2 on page 15.





WHAT IS YOUR RETURN POLICY?

As stated on each product listing as well as on our policy page: we allow 60 Day Returns of uninstalled, standard sized brackets, home decor, and wood shelves*. Custom Products (that are not offered on our standard listings) will not be accepted for returns or exchanges. You must notify us with the intent to return within 30 days of receiving your order. Qualifying orders will have a 15% manufacturing and shipping fee.

*For any wood shelf returns, there will be a 30% manufacturing and shipping fee. Due to their custom nature, glass and metal shelves, will not be accepted for return.

WHAT IS YOUR EXCHANGE POLICY?

We offer free exchanges on all of our standard sized, in-stock brackets and home decor products within 60 days. However the product should be uninstalled and with the original packaging to ensure it gets to us without damage. For wood shelf exchanges, there will be a 15% manufacturing and shipping fee. Due to their custom nature, glass and metal shelves, will not be accepted for exchange.

HOW DO I RETURN MY ORDER?

If you are able to return your order, based on the guidelines outlined in the first question, please scan the [QR Code](#) below. If your order does not meet the guidelines above, then your request will be denied. However, if you have any questions, please reach out to us at help@ironabode.com.

Need More Assistance?

Phone: (208) 258-9733

E-mail: help@ironabode.com

For more tips and videos, go to ironabode.com/installationguides

