

RVH8333

UNDERMOUNT WORKSTATION SINK

RUVATI[®]
SPECIFICATION SHEET

MATERIAL

True 16 Gauge Thickness
Premium T304 Grade Stainless Steel
18/10 Chromium/Nickel Content
Commercial Brushed Finish



FEATURES

- Heavy duty sound guard padding and undercoating
- Slanted bottom with elegant drain grooves for easy draining
- Dual-Tier Ledge for Accessories

Included Inside:

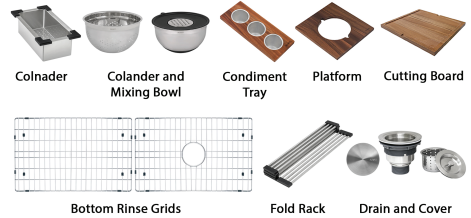

IN THE BOX

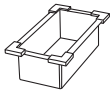

Collander
[RVA1310]



Folding Rack
[RVA1395]

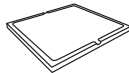

Cutting Board
[RVA1233]



Condiment
Serving Tray
[RVA1377]



Mixing Bowl and Platform
[RVA1288]



Basket Strainer
[RVA1025]



Drain Cover
[RVA1035]

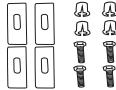

Mounting Clips
[RVA11031]



Cut-out
Template

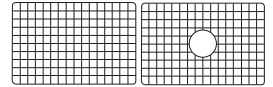

Rinse Grid
[RVA68555]

NOMINAL DIMENSIONS

Exterior: 45" (wide) x 19" (front-to-back)
Interior Bowl: 43³/₈" (wide) x 14⁵/₈" (front-to-back)
Bowl Depth: 10"
Minimum Cabinet Size: 48" wide
Drain Hole Size: 3¹/₂"

Installation Type:
Undermount
Inside Corners:
Zero Radius
Drain Location:
Offset

RUVATI USA

www.ruvati.com

Phone: 1.855.478.8284
Email: support@ruvati.com

OPTIONAL ACCESSORIES (SOLD SEPARATELY)



Deep Basket
Disposal Flange
[RVA1049ST]

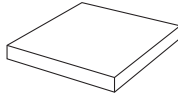

Butcher Block
[RVA2445ACA]

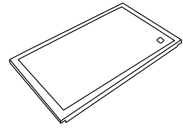

Black Plastic
Cutting Board
[RVA1217BLK]

DIMENSIONS

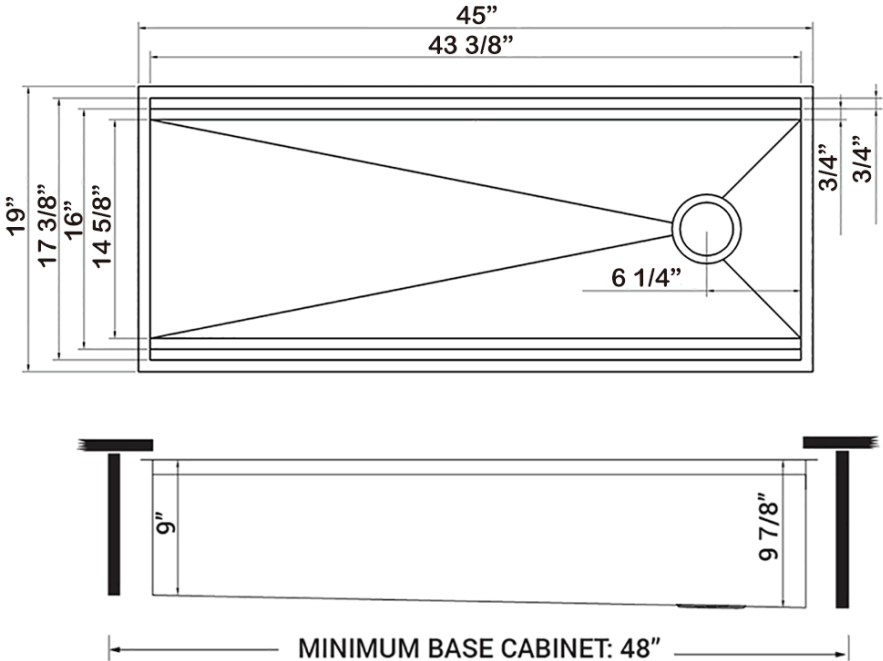

Register your product at www.ruvati.com/register.