

# Installation Guide

PERLATO

## Perlato Fireclay Sinks

### IMPORTANT

Before beginning installation, make sure that the sink is the correct model and size and conduct a thorough inspection. It is recommended to inspect sink for damage even if it was previously inspected.

1. Insert pencil through holes on back of sink to mark wall. Alternatively, measure distance between holes and mark wall appropriately.

Ensure sink will be anchored to wall studs or reinforced wall for support.

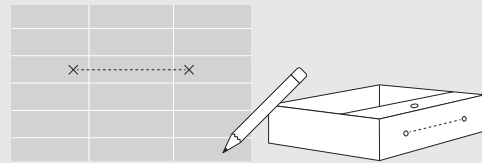

2. Drill mounting holes in wall.

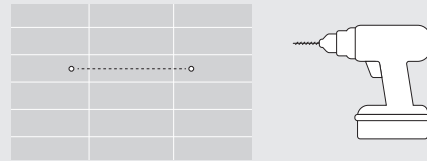

3. Attach faucet and drain to sink.

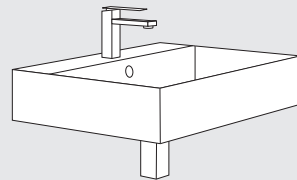

4. Apply silicone to back of sink.

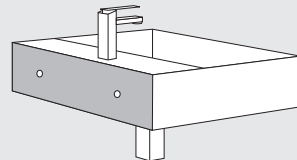

5. Attach sink to wall using bolts and large washers through back of sink.

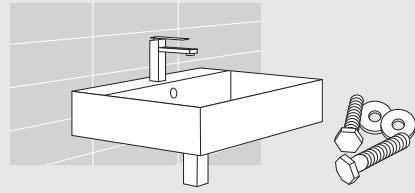

6. Connect water supply and drain lines.

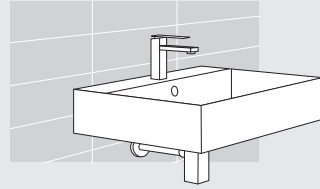

7. Run faucet and check for leaks.

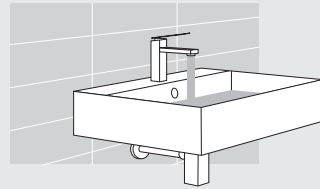

### Towel Bar *optional*

---

If towel bars are not used, the four screws beneath sink may be discarded.

Unfasten screws on bottom of sink, position towel bar, then secure screws.

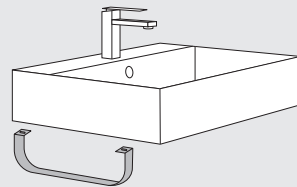

# Slim Square

PSQ2018

19<sup>7</sup>/<sub>8</sub>" W x 18<sup>1</sup>/<sub>4</sub>" D x 4<sup>7</sup>/<sub>8</sub>" H

Available in 5 widths: 20", 24", 32", 40", 48"



 Made in Italy

Wall-mounted bathroom sink

Fine fireclay

Overflow in polished chrome finish

Weight: 22lbs

Available finishes:

White  Matte Black

Optional mounting hardware available

 1-hole tap

 3-hole tap

## Slim Towel Bar *optional*

Brass towel bar easily attaches to underside of sink

Includes overflow ring in matching finish:

Polished Chrome  White Gloss  
 Brushed Nickel  Matte Black



no towel bar

1 towel bar  
left side

1 towel bar  
right side

2 towel bars  
both sides

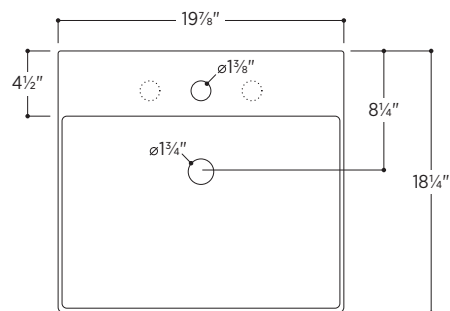
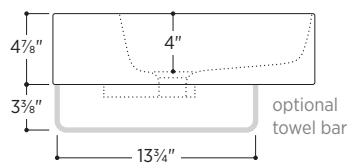

All measurements are approximate and for comparison only. Please note that these dimensions and specifications are subject to change without notice. Our products must be installed by certified professionals only and according to our installation guide, as well as federal, provincial/state and local building codes and regulations.

# Slim Square

PSQ2418

23<sup>3</sup>/<sub>4</sub>" W x 18<sup>1</sup>/<sub>4</sub>" D x 4<sup>7</sup>/<sub>8</sub>" H

Available in 5 widths: 20", 24", 32", 40", 48"



 Made in Italy

Wall-mounted bathroom sink

Fine fireclay

Overflow in polished chrome finish

Weight: 26.5lbs

Available finishes:

White  Matte Black

Optional mounting hardware available



1-hole tap

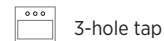

3-hole tap

## Slim Towel Bar *optional*

Brass towel bar easily attaches to underside of sink

Includes overflow ring in matching finish:

Polished Chrome  White Gloss  
 Brushed Nickel  Matte Black

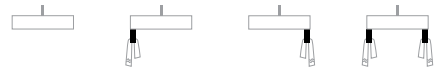

no towel bar

1 towel bar  
left side

1 towel bar  
right side

2 towel bars  
both sides

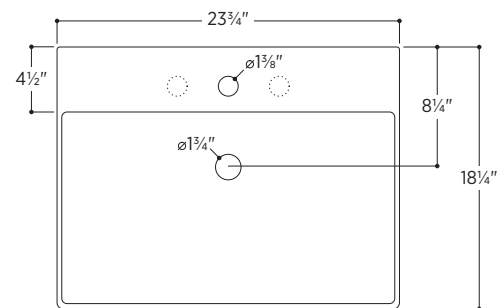
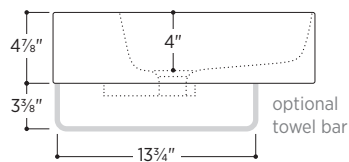

All measurements are approximate and for comparison only. Please note that these dimensions and specifications are subject to change without notice. Our products must be installed by certified professionals only and according to our installation guide, as well as federal, provincial/state and local building codes and regulations.

# Slim Square

PSQ3218

31<sup>5</sup>/<sub>8</sub>" W x 18<sup>1</sup>/<sub>4</sub>" D x 4<sup>7</sup>/<sub>8</sub>" H

Available in 5 widths: 20", 24", 32", 40", 48"



 Made in Italy

Wall-mounted bathroom sink

Fine fireclay

Overflow in polished chrome finish

Weight: 39.7lbs

Available finishes:

White  Matte Black

Optional mounting hardware available

 1-hole tap

## Slim Towel Bar *optional*

Brass towel bar easily attaches to underside of sink

Includes overflow ring in matching finish:

Polished Chrome  White Gloss  
 Brushed Nickel  Matte Black

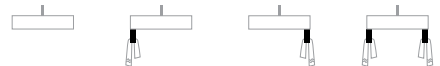

no towel bar    1 towel bar left side    1 towel bar right side    2 towel bars both sides

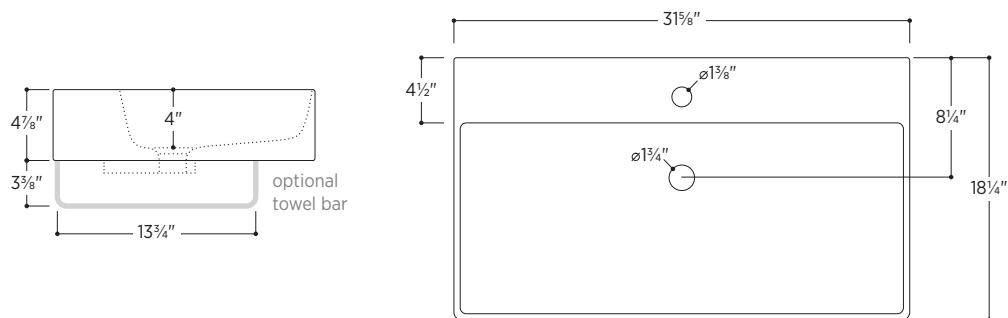

All measurements are approximate and for comparison only. Please note that these dimensions and specifications are subject to change without notice. Our products must be installed by certified professionals only and according to our installation guide, as well as federal, provincial/state and local building codes and regulations.

# Slim Square

PSQ4018

39½" W x 18¼" D x 4⅞" H

Available in 5 widths: 20", 24", 32", 40", 48"



 Made in Italy

Wall-mounted bathroom sink

Fine fireclay

Overflow in polished chrome finish

Weight: 55.1lbs

Available finishes:

White  Matte Black

Optional mounting hardware available

 1-hole tap

## Slim Towel Bar *optional*

Brass towel bar easily attaches to underside of sink

Includes overflow ring in matching finish:

Polished Chrome  White Gloss  
 Brushed Nickel  Matte Black

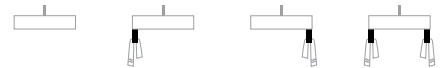

no towel bar    1 towel bar left side    1 towel bar right side    2 towel bars both sides

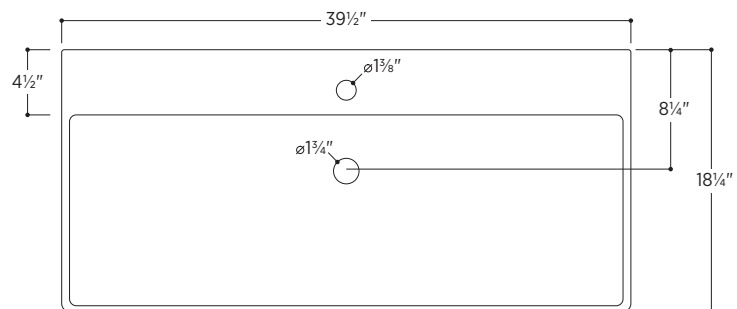
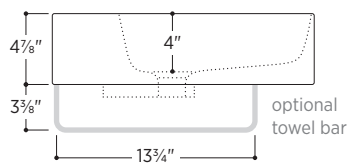

All measurements are approximate and for comparison only. Please note that these dimensions and specifications are subject to change without notice. Our products must be installed by certified professionals only and according to our installation guide, as well as federal, provincial/state and local building codes and regulations.

# Slim Square

PSQ4818

47<sup>3</sup>/<sub>8</sub>" W x 18<sup>1</sup>/<sub>4</sub>" D x 4<sup>7</sup>/<sub>8</sub>" H

Available in 5 widths: 20", 24", 32", 40", 48"



 Made in Italy

Wall-mounted bathroom sink

Fine fireclay

Overflow in polished chrome finish

Weight: 57.3lbs

Available finishes:

White  Matte Black

Optional mounting hardware available

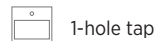

1-hole tap

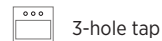

3-hole tap

## Slim Towel Bar *optional*

Brass towel bar easily attaches to underside of sink

Includes overflow ring in matching finish:

Polished Chrome  White Gloss  
 Brushed Nickel  Matte Black



no towel bar



1 towel bar  
left side



1 towel bar  
right side



2 towel bars  
both sides

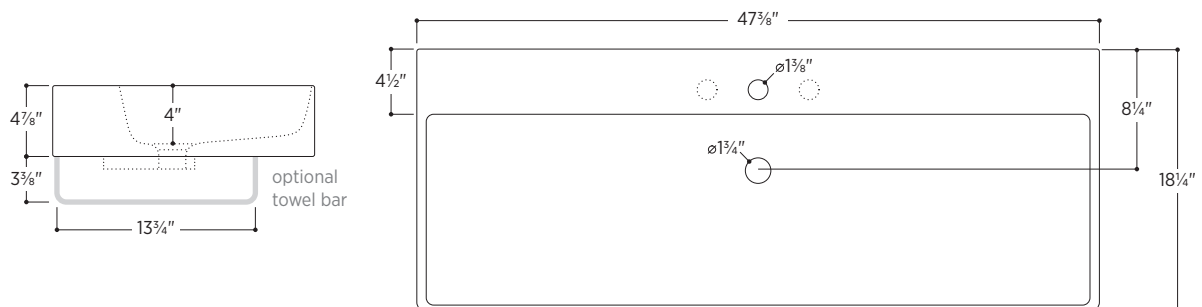

All measurements are approximate and for comparison only. Please note that these dimensions and specifications are subject to change without notice. Our products must be installed by certified professionals only and according to our installation guide, as well as federal, provincial/state and local building codes and regulations.