





-  brushed
RJ11-BR
-  matte black
RJ11-MB

SPECIFICATIONS

MATERIAL:	316 marine grade stainless steel
FEATURES:	pressure balance valve two-way diverter hand shower built-in part for easy installation protective cover included
WEIGHT:	38 lbs
PACKAGE DIMENSIONS:	L 55" x W 23" x H 11"
DELIVERY WEIGHT:	45 lbs

MAINTENANCE & CARE

BRUSHED:	Regularly apply stainless steel cleaner and rub in the direction of the grain, using a slightly abrasive sponge.
MATTE BLACK:	Regularly clean with soap water or alcohol. Do not use abrasives.

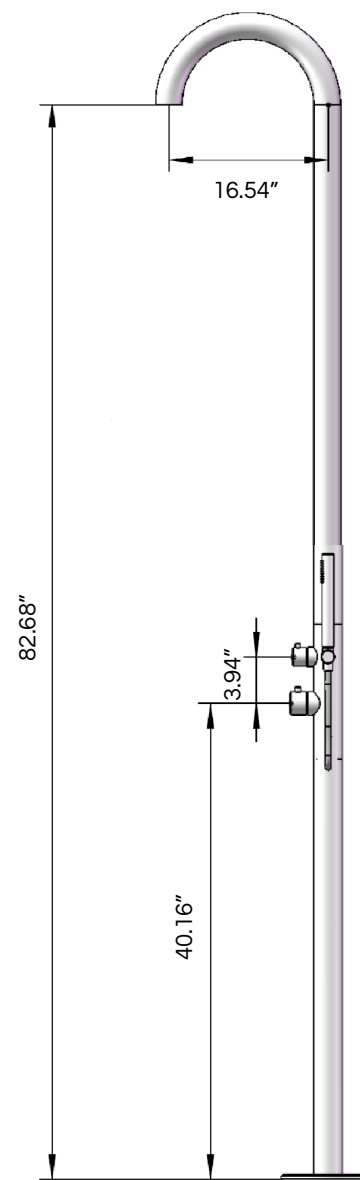
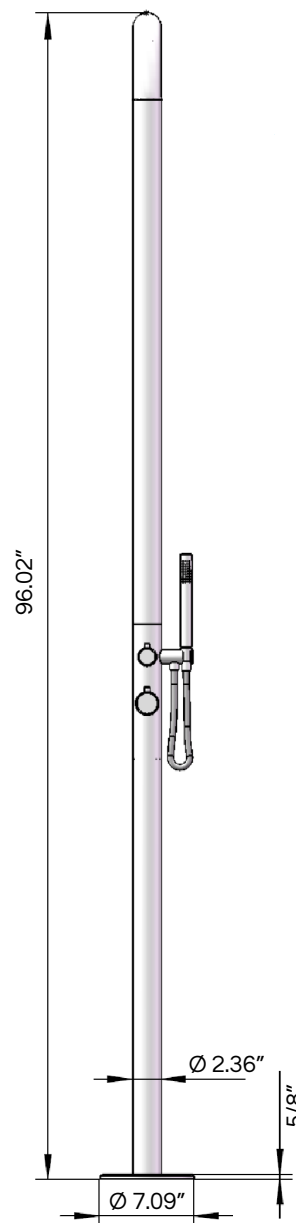

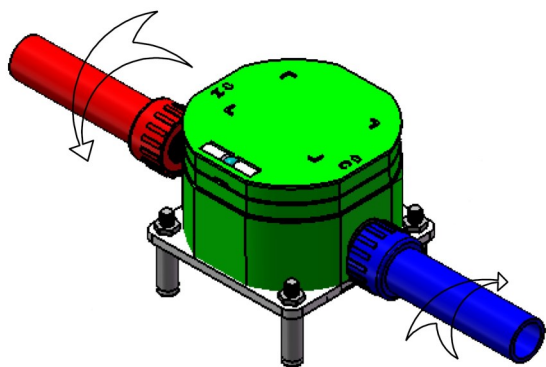

BUILT-IN PART FOR INSTALLATION

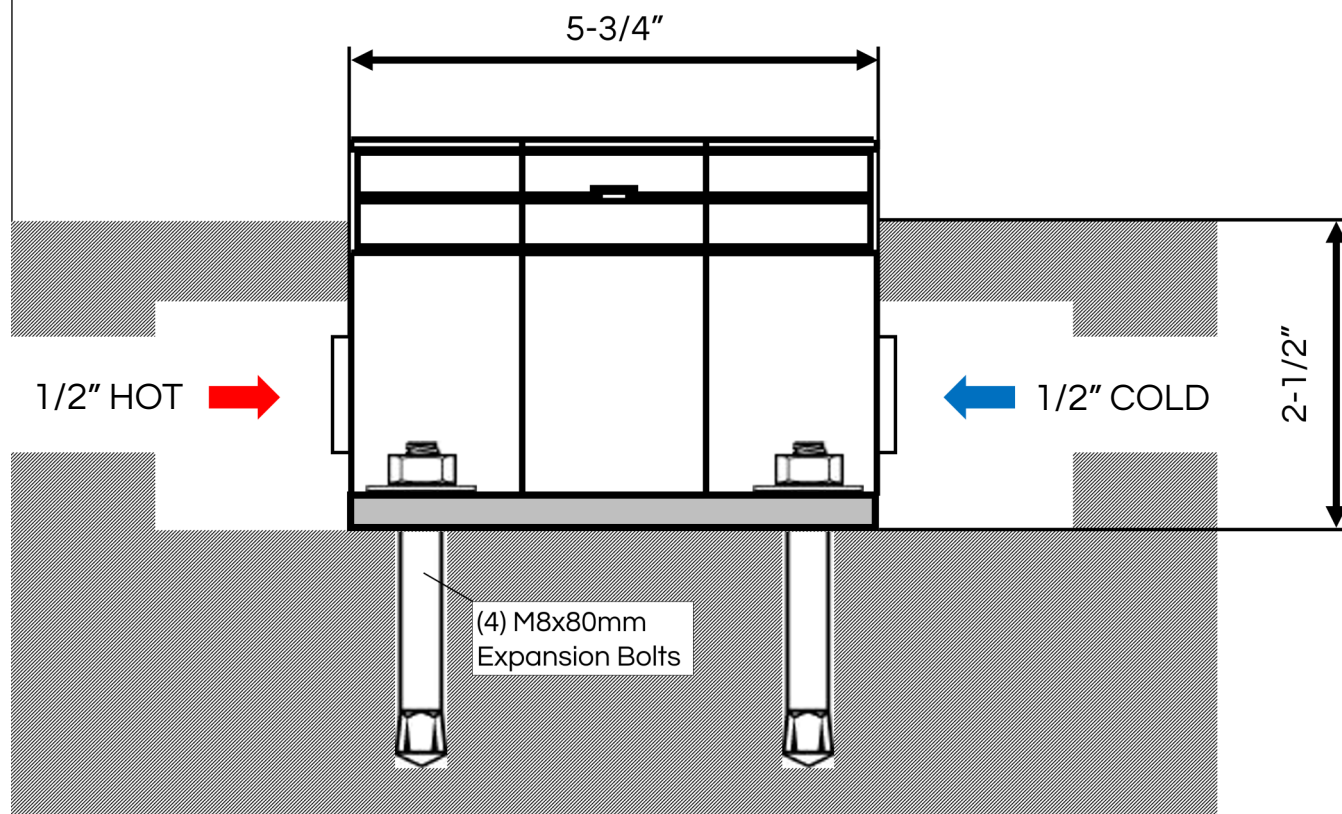

FLOOR INSTALLATION DETAIL





-  brushed
RJ03-BR
-  matte black
RJ03-MB

SPECIFICATIONS

MATERIAL:	316 marine grade stainless steel
FEATURES:	pressure balance valve two-way diverter foot wash built-in part for easy installation protective cover included
WEIGHT:	38 lbs
PACKAGE DIMENSIONS:	L 55" x W 23" x H 11"
DELIVERY WEIGHT:	45 lbs

MAINTENANCE & CARE

BRUSHED:	Regularly apply stainless steel cleaner and rub in the direction of the grain, using a slightly abrasive sponge.
MATTE BLACK:	Regularly clean with soap water or alcohol. Do not use abrasives.

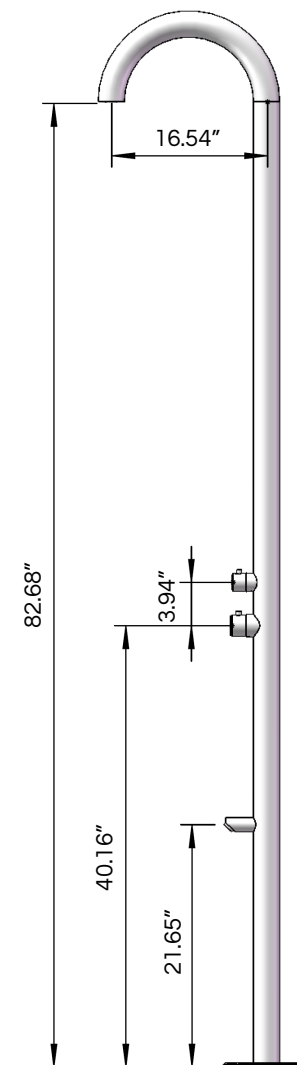
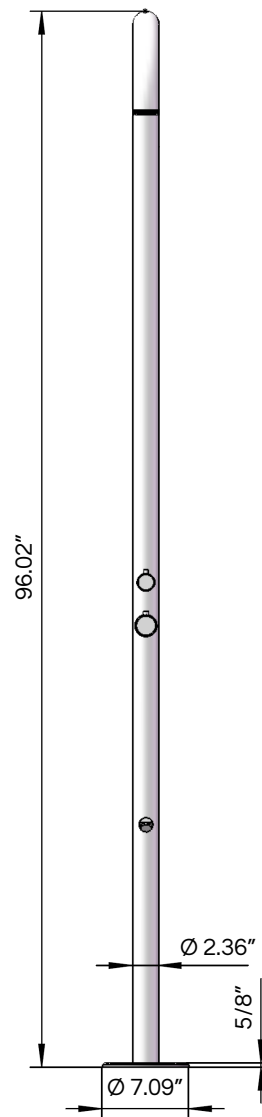

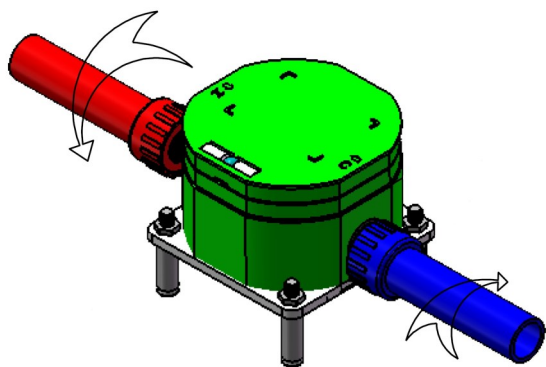

BUILT-IN PART FOR INSTALLATION

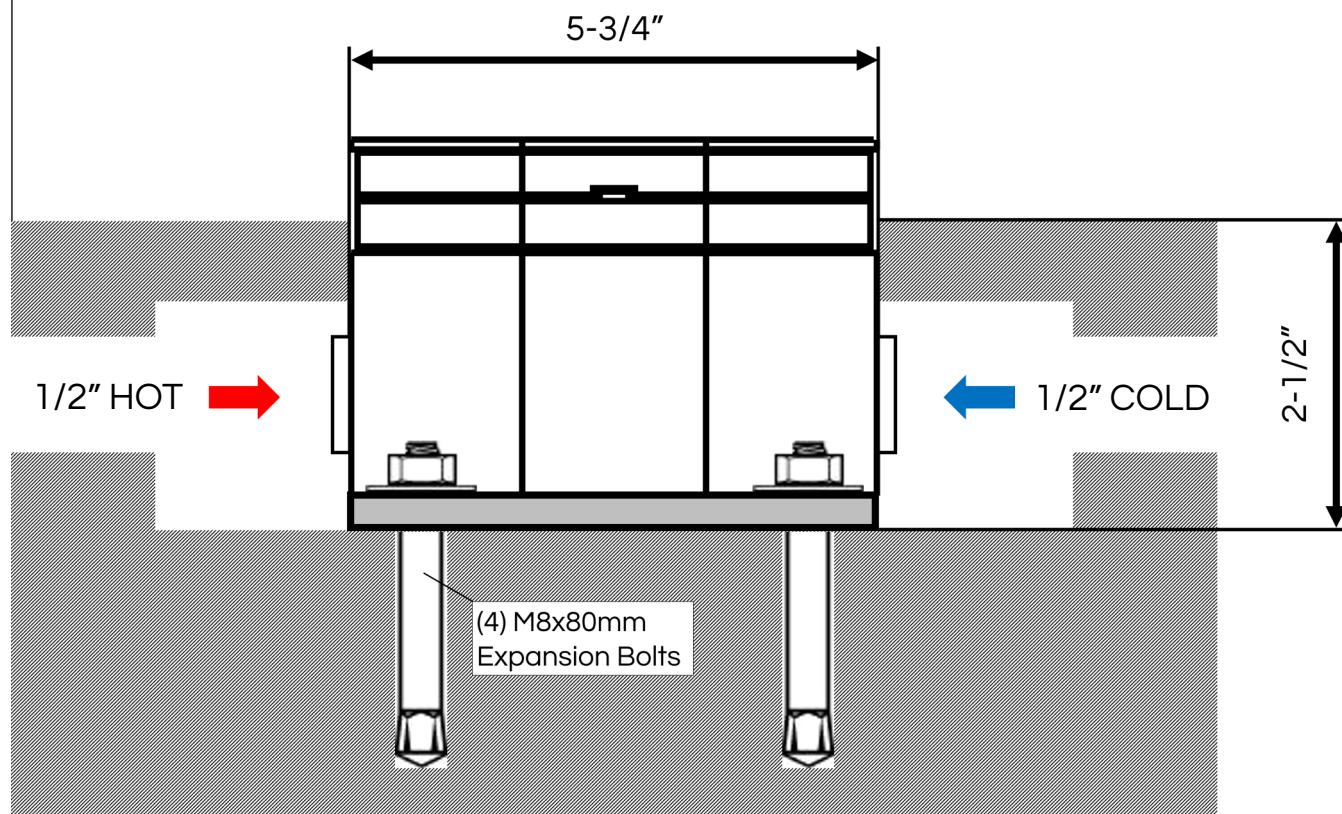

FLOOR INSTALLATION DETAIL





-  brushed
RJ02-BR
-  matte black
RJ02-MB

SPECIFICATIONS

MATERIAL:	316 marine grade stainless steel
FEATURES:	pressure balance valve two-way diverter hand shower rain shower head built-in part for easy installation protective cover included
WEIGHT:	36 lbs
PACKAGE DIMENSIONS:	L 51" x W 23" x H 11"
DELIVERY WEIGHT:	43 lbs

MAINTENANCE & CARE

BRUSHED:	Regularly apply stainless steel cleaner and rub in the direction of the grain, using a slightly abrasive sponge.
MATTE BLACK:	Regularly clean with soap water or alcohol. Do not use abrasives.

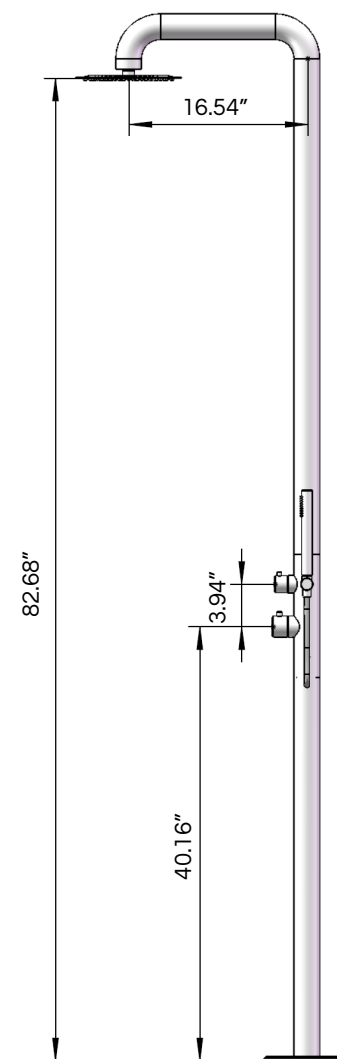
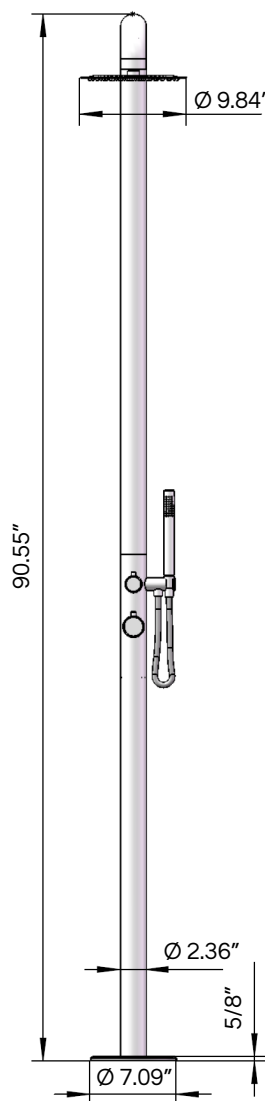

BUILT-IN PART FOR INSTALLATION

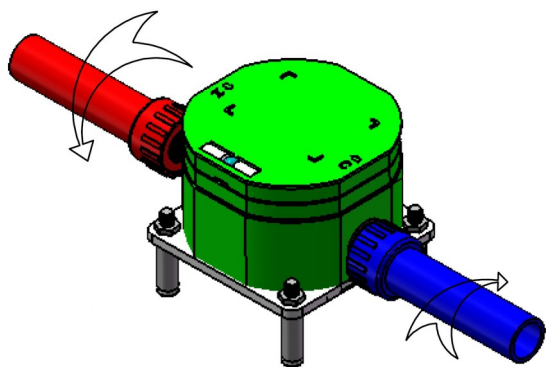

FLOOR INSTALLATION DETAIL

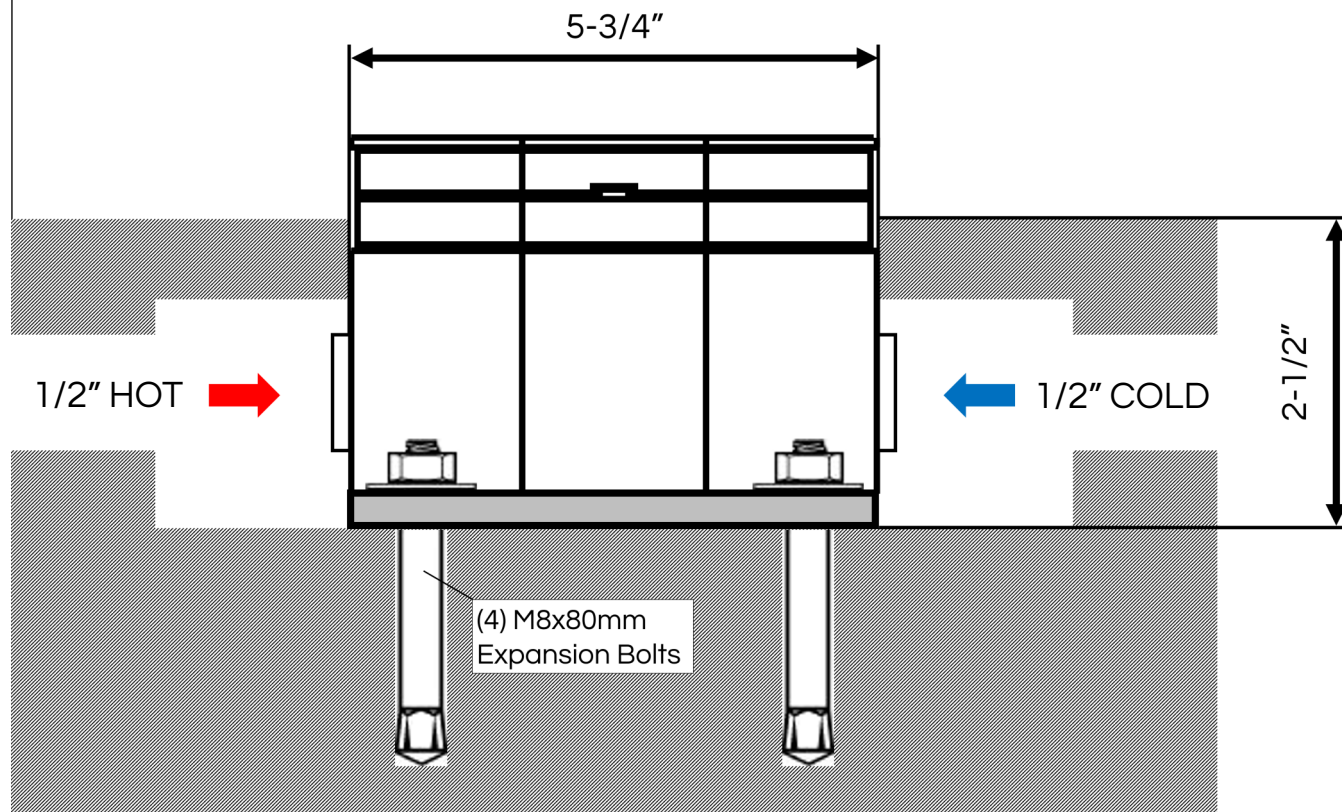

1

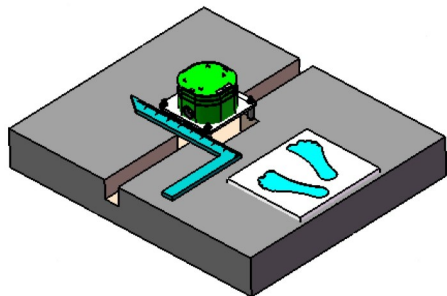

Place the built-in part in the desired position. Mark and drill the (4) holes.

2

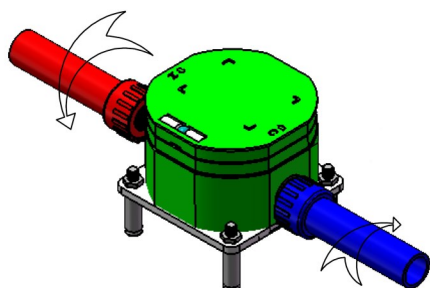

Connect the hot and cold supply pipes to the built-in part and test for any leaks.

3

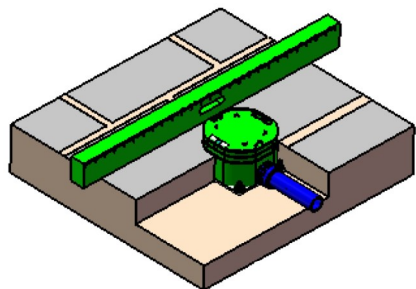

Make sure the built-in part is level and aligned. Secure by tightening the (4) expansion bolts.

4

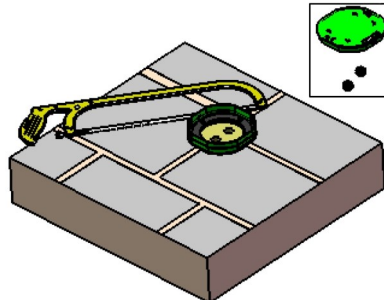

Remove the cover and outlet plugs. Cut off the excess portion of the built-in part.

5

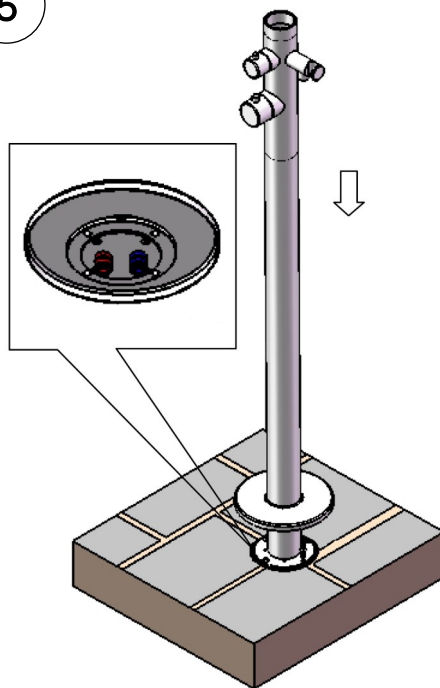

Place the lower half of the shower onto the built-in part and secure into place with (4) screws.

6

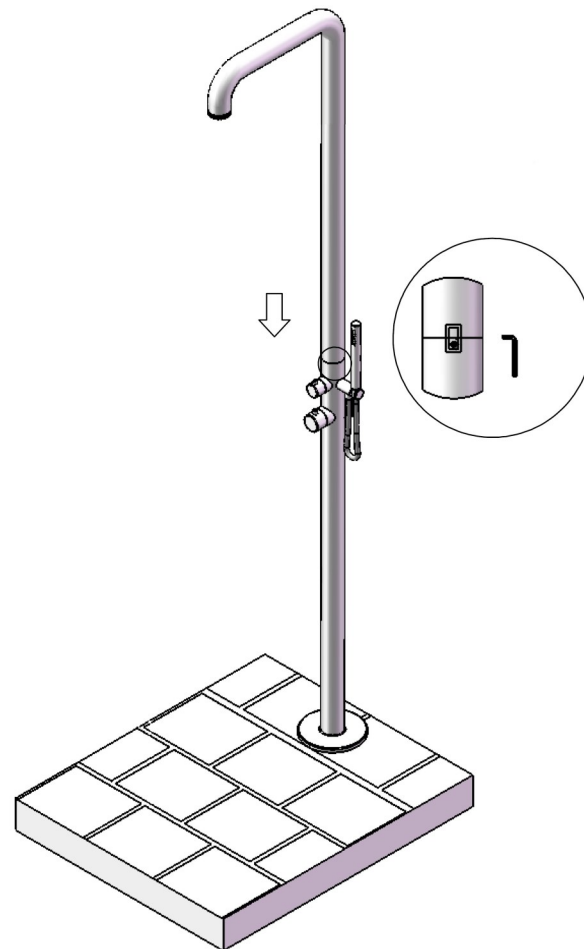

Insert the upper half of the shower into the lower half. Align and secure the screw on the back side of the shower.