

# Jackson Installation Sheet

skill level

● skill level

## installation instructions

*For a safe installation make sure that the electrical box is securely mounted to a structural member of the building.*

1. Remove brass mounting screws from crossbar
2. Turn the fixture over so the back side is facing up
3. Turn the crossbar so the sliding tabs and their screw heads are facing up
4. Loosen the screws on the crossbar to allow the tabs to slide freely
5. Align the center of the crossbar with the center of the fixture
6. Keeping the cross bar centered on the canopy, align the threaded holes on the sliding tabs with the mounting holes on the canopy
7. From the front side, install the brass mounting screws through the canopy and into the threaded holes on the crossbar's sliding tabs
8. Tighten the screws on the crossbar to lock the sliding tabs in place
9. Remove the brass mounting screws from the crossbar
10. With the screw heads pointing out, attach the crossbar to the electrical box using the screws supplied with the electrical box
11. Make wiring connections in accordance with local electrical codes. See "Important Information" on reverse side
12. Align mounting holes on the canopy with the threaded mounting holes on the crossbar and install the mounting screws until the fixture is fully seated

See "Important Information" on reverse side.

*Complete !*

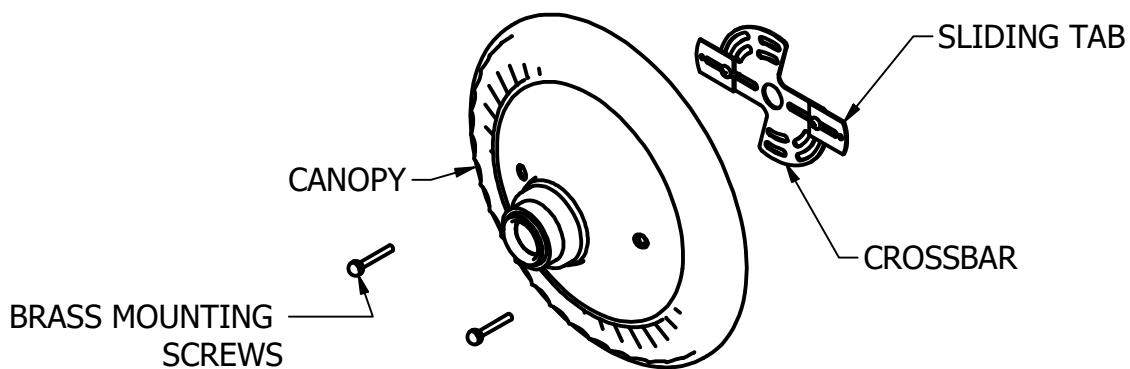

## REJUVENATION

2550 N.W. Nicolai Street, Portland Oregon 97210 Customer Service: 888-401-1900 rejuvenation.com

● toolbox

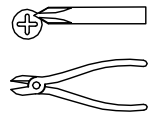

# Important Information

skill level • basic electrician

## Please read before installing your fixture!

**CALIFORNIA PROPOSITION 65 WARNING:** This product contains brass hardware components which contain lead, a heavy metal known by the State of California to cause cancer, birth defects, or other reproductive harm.

1. Before removing the old fixture or installing the new fixture, shut off the power to the electrical box by removing the fuse or shutting off the circuit breaker for that circuit.
2. Fixture wires must be connected to the appropriate house wires - black fixture wire to black (power) house wire and white fixture wire to white (neutral) house wire. If your fixture has lamp cord wire, connect the smooth fixture wire to the black (power) house wire and connect the fixture wire with the ridges along the outer edge to the white (neutral) house wire.

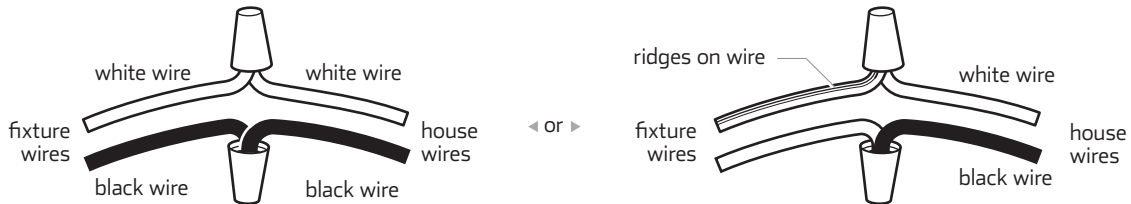

3. If your fixture has a bare ground wire, where you connect it depends on the wiring in your house. Never connect it to a current carrying wire. If your house has **metal** electrical boxes, connect the fixture ground wire to the green ground screw on the crossbar. If your house is newer or has been rewired and has **plastic** electrical boxes, connect the fixture ground wire to the house ground wire. If your fixture does **not** have a ground wire, your house ground wire can be connected directly to the crossbar using the green screw installed on the crossbar.
4. If your fixture has a switch in the canopy, connect one switch wire to the black (power) wire of the house, and the other to the black wire(s) from the fixture.
5. Leave no bare wires exposed after installation (except the bare ground wire, if any). Stripped ends of joined wires must be completely covered by wire nuts. Make sure that you do not damage the fixture wire insulation or the house wire insulation during installation.
6. Do not leave any wires in contact with sharp metal edges.
7. When installing shades, do not over-tighten the screws holding them. The shade should be held securely, but still be able to be turned in the shade holder.
8. Only use light bulbs of the correct type and no greater wattage than specified for your fixture. Using higher wattage bulbs or certain “decorator” type bulbs will shorten the life of the fixture and may create a fire hazard.
9. Turn off the power to the fixture at the wall or canopy switch before installing light bulbs.
10. If your fixture has become slightly misaligned during shipping you can often “tweak” it back into alignment with a gentle twist. If this doesn’t work, give us a call for further advice.
11. If your fixture has a **UL Wet Location Rating**, additional precautions need to be taken. Fixtures with glass shades must be installed shade up. All supplied rubber washers must be installed between screw heads and the fixture canopy. After installation, all wet location fixtures must be caulked with suitable RTV or silicone caulking around the top, sides and bottom of the fixture where they contact the wall, and the top sides, and bottom of the joint between the canopy and the body of the fixture.  
Drain holes in fixture should be routinely cleaned to prevent an accumulation of water.

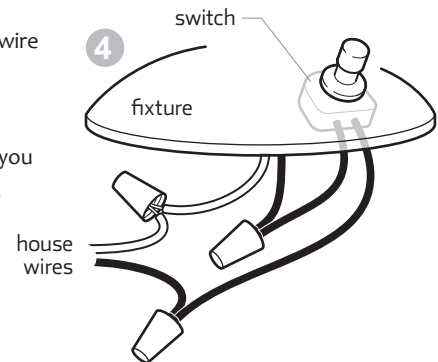

• toolbox

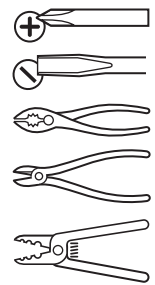

### Materials Needed

- Wire connectors (not supplied - the size depends on the number and size of the wires being joined).
- Crossbar mounting screws. These should be supplied with the electrical box. If you need to replace them try 8-32 x 1/2”

**\* If you have any doubts about how to install a light fixture, or if a fixture fails to operate properly, please contact a local licensed electrician.**

# REJUVENATION

# Installation sheet side canopy screw mount

skill level

• basic electrician

## installation instructions

For a safe installation make sure that the electrical box is securely mounted to a structural member of the building.

1. Attach **crossbar** to electrical box using screws supplied with the box.

These fixtures are supplied with a unique crossbar. Most have curved slots in **crossbar** to allow fixtures to be squared to the room, regardless of position of screw holes in the electrical box.

2. Make wiring connections in accordance with local electrical codes.

See “Important Information” on reverse side.

3. Using all **canopy screws** supplied with the fixture, attach fixture to **crossbar** through holes in **canopy** sides.

Complete!

## • toolbox

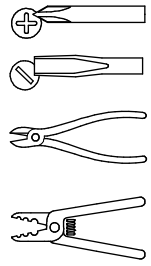

### RECTANGULAR CANOPY

### ROUND CANOPY

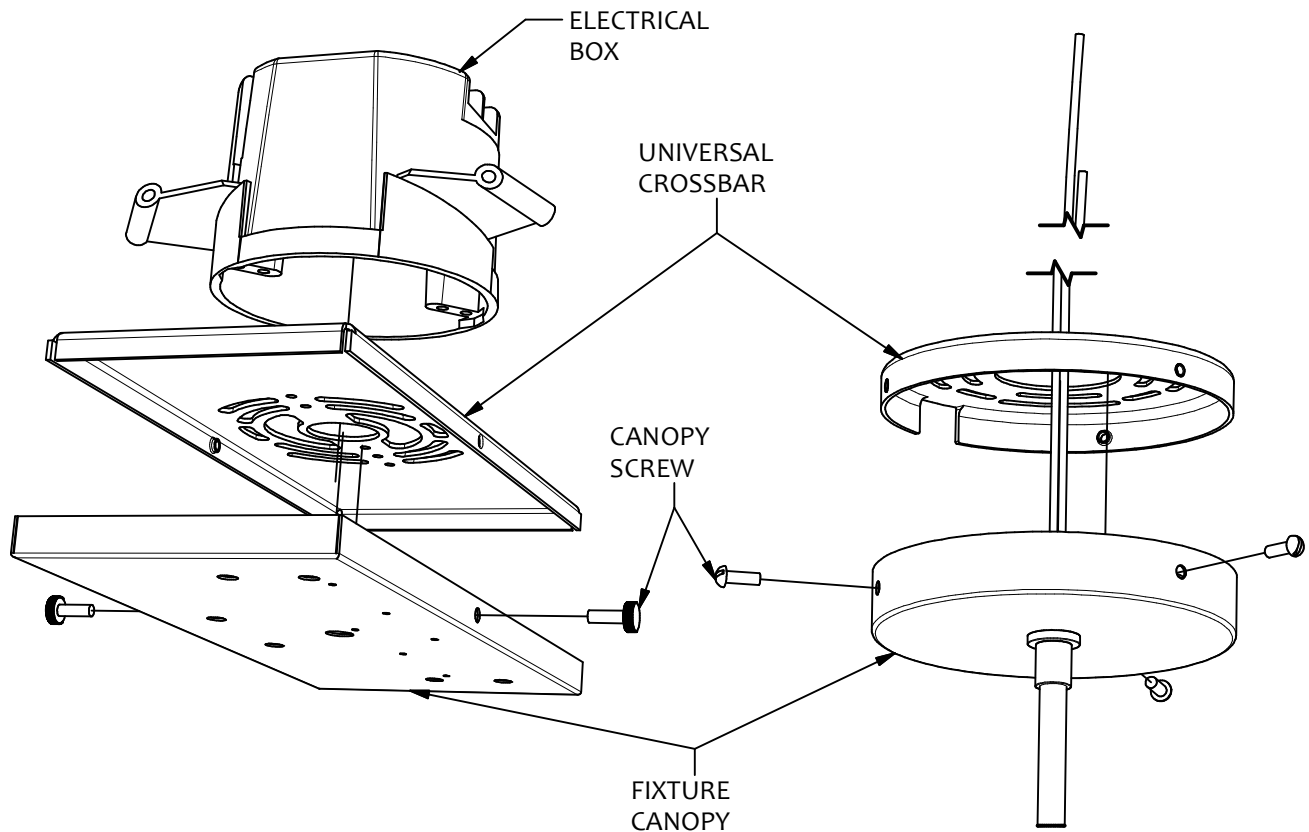

# REJUVENATION®